

Single Folding Gate: 11'-12' Wide

IllinoisEngineeredProducts.com
877.437.4623

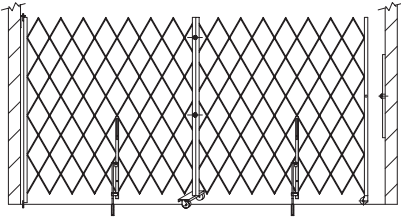





Finished Assembly



Parts Needed

5/16" x 2" Long Lag Bolt
Masonry Door Frame or Wall Installations
(wall installation may require lead anchor)

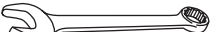
Tools Needed

3/4" Masonry Drill Bit 
1/4" Masonry or Wood Drill Bit 
Flathead Screwdriver 
1/2" (13mm) Wrench or Socket 
9/16" (14 mm) Wrench or Socket 

Parts Included

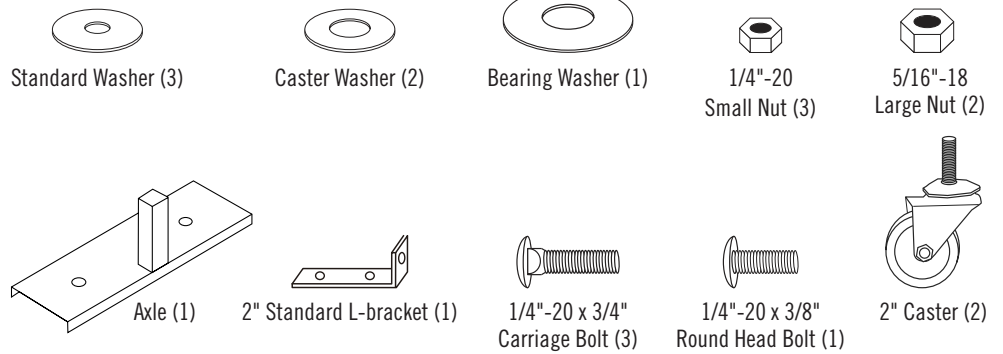

INSTALLATION INSTRUCTIONS

1) Before installing, decide on gate placement. L-brackets that form top hinge allow gate placement in the recess of door frame. Installation can also be made outside or inside of wall next to door or opening frame. (See Figure 1A & 1B)

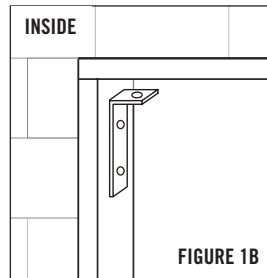
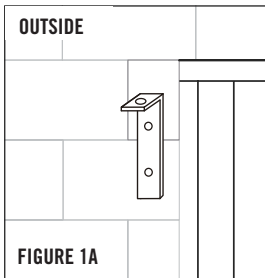

NOTE: Either side of gate can be toward the outside of building. A label on the operating side (the side with the center drop pins) indicates RHT (right) or FT (left) of a person facing the operating side.

2) Bolt inner and outer panels together at the top, middle and bottom by using carriage bolts, standard washers and small nuts. Repeat for remaining gate panels. (See Figure 2)

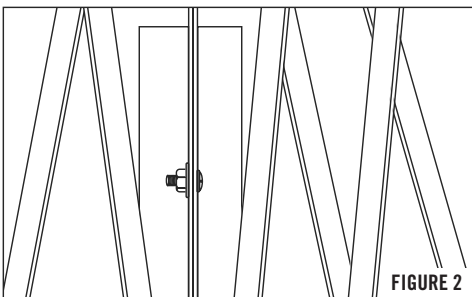

3) Attach casters to axles. Put caster through the opening in the axle and tighten with caster washer and large nut. (See Figure 3)

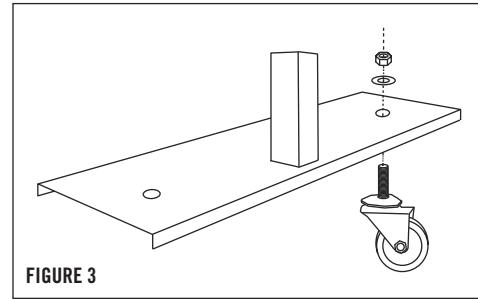

4) Insert each gate end onto axle support. Insert round head bolt and tighten with screwdriver. (See Figure 4)

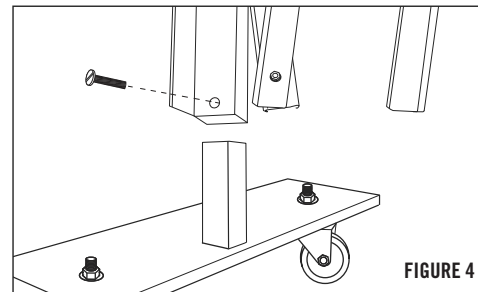

INSTALLATION INSTRUCTIONS

- 5) Have a helper extend the gate and stand it upright where it will be mounted. Drill a 3/4" diameter x 3" deep hole, 1/4" from wall into the floor for gate pin to set into. Place a bearing washer over floor hole and set bottom gate pin into floor mount hole. (See Figure 5) Repeat on other side.

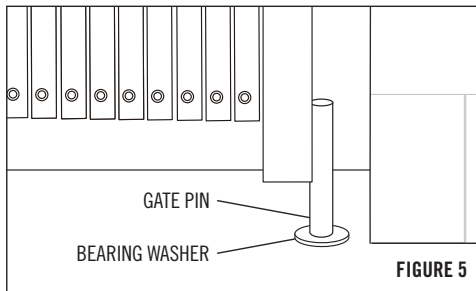

Scan to view video



- 6) Extend gate and hang L-bracket on top of gate to verify where it will be mounted. To release tension, lift the wheel 1/2 - 3/4" off the floor. Mark and drill pilot holes into door frame or wall. It may be easier to drill pilot holes if you remove the gate from its floor mount. Place bearing washer and bottom gate pin back into floor mount. Slip "L" bracket over top of gate and 5/16 x 2" lag bolt (not included.) (See Figure 6)

- Wood door frames or walls: 5/16 x 2" lag bolts.
- Steel door frames or walls: Drill & tap for 5/16" x 2" lag bolts.
- Brick or concrete frames or walls: 5/16" x 2" Lag bolts set into 3/8" holes with lead anchors.

